

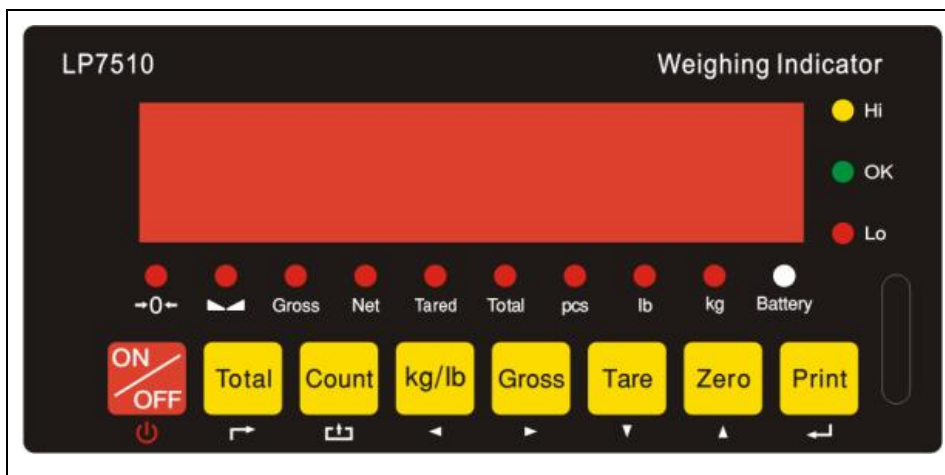

LP7510

Weighing indicator

USER MANUAL



Edition:10052001A



Safety Instruction

For safety operation pls. follow the safety instruction.



WARNING

Setting, Calibration Inspection and Maintain of the indicator is prohibited by Non-professional staff.



WARNING

Pls. make sure the weighing display have good ground in using



WARNING

The indicator is the static and sensitive equipment, cut off the power during electrical connections, internal components touched by hand is prohibited, and please take the measure of anti-static.

LIST

1. Instruction	1
1.1 Main function	1
1.2 Technical parameter	1
1.3 Drawing	2
1.4 Battery instruction	3
2. Installation and calibration.....	4
2.1 Power supply connection	4
2.2 Loadcell connection.....	4
2.3 communication interface	5
2.4 4~20mA	6
2.5 Relay output signal	6
3. Basic operation	9
3.1 Keyboards.....	9
3.2 Power on.....	11
3.3 Zero function.....	11
3.4 Tare function	11
3.5 Total function.....	11
3.6 Print function.....	13
3.7 Hold function.....	13
4. Calibration and Technical parameter setting	13
4.1 Enter calibration.....	13
4.2 Calibration.....	14
4.3 Technical parameter setting.....	16
5. Output format	22
5.1 Second display continuous output	22
5.2 Computer continuous output	22
5.3 Serial interface receive PC command.....	23
5.4 Print output format.....	24
5.5 PC/ Second display continuous output format	24
6. Maintain.....	25
6.1 Troubleshooting for common problems	25
6.2 Daily maintenance	26
6.3 Default parameter recovery	26
6.4 Packing list.....	29

1. Instruction

This weighing indicator is designed for bench scale. Floor scale, the basic weighing function include: Hold. Print kg/lb conversion . optional: I/O , 4-20mA output.

1.1 Main function

Weighing function:

Zero, tare, G.W, N.W, accumulation. printing, animal -weighing.
kg/lb convert. Overload remind.

Print format: S.N. G.W N.W Tare. Date, Time

Options:

Pinter

RS232/RS485 serial interface or second display

I/O

4-20mA

1.2 technical parameter

Accuracy class	6000 e	
Resolution	display: 30, 000	ADC: 2,000,000
Zero stability error	$TK_0 < 0.1\mu V//K$	
Span stability error	$TK_{spn} < \pm 6 \text{ ppm//K}$	
Sensitivity (internal)	$0.3 \mu V / d$	
Input voltage	-30~30mV DC	
Excitation circuit	5 VDC, 4 wire connection, Maximum connect 6 load cell of 350Ω	
AC power	AC100~250V	
Operation temperature	- 10 °C ~ + 40 °C	
Operation humidity	≤90%RH	
Storage temperature	- 40 °C ~ + 70 °C	

1.3 Outline (mm)

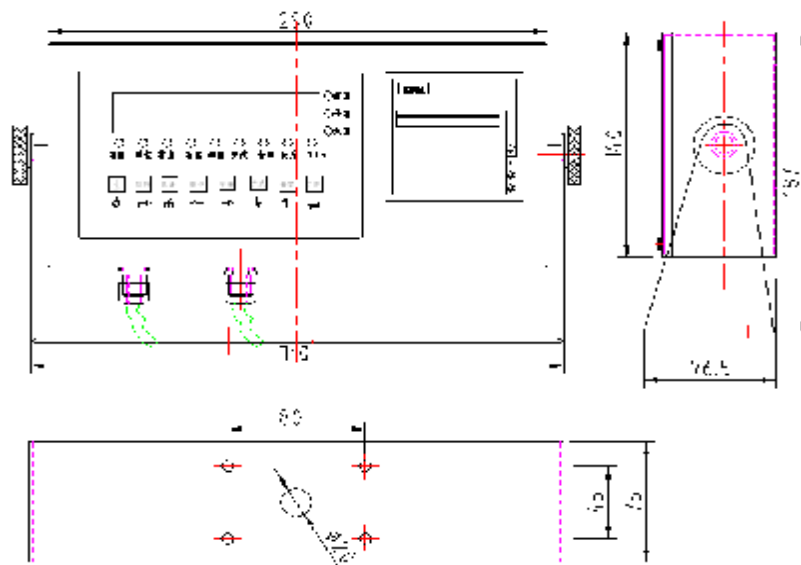
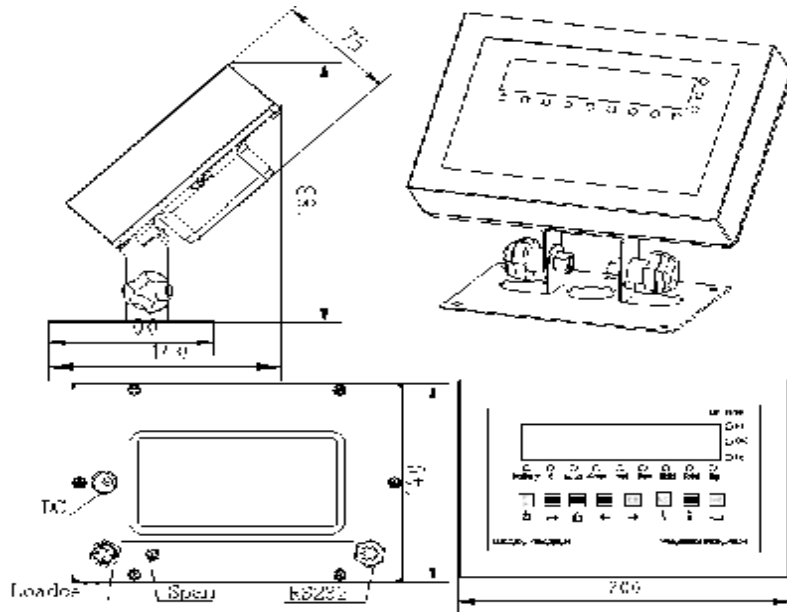

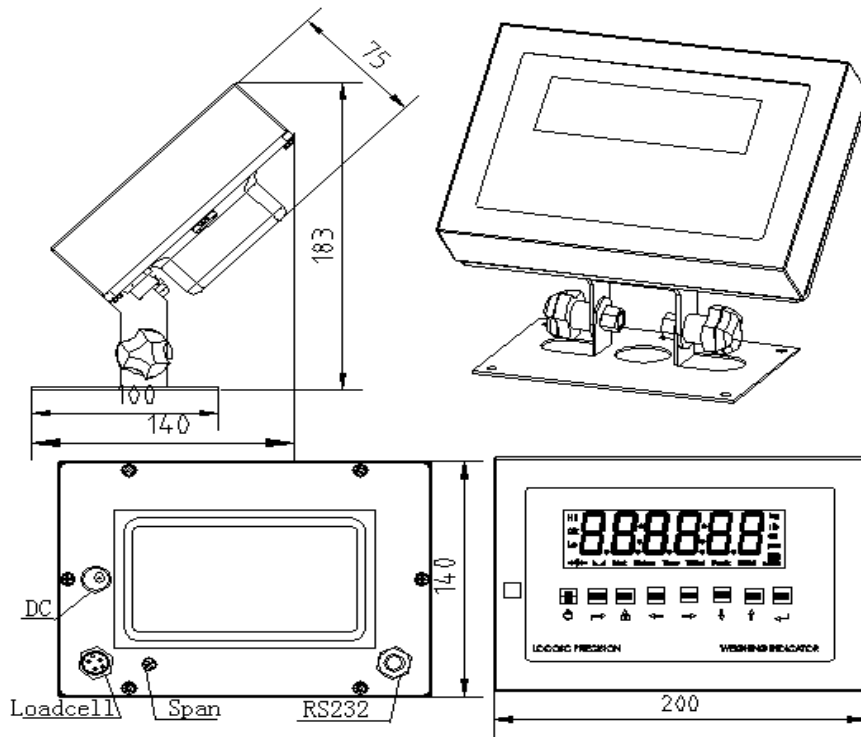

1.4 Battery instruction

1. . when you use the internal battery first time, you should charge the battery fully, to prevent low voltage resulted from self leakage of battery.
2. when the “battery” light is on, means low battery, pls. charge it in time
3. the light turns to yellow during charging
4. when the light turns to green, means fully charged.
5. if battery is not used for long time, take it out to avoid the leakage.
6. In order to keep the battery in best using condition, it is suggest that you fully discharge the battery every month, the method is that using the indicator till it is automatically power off.

2. Installation and calibration

2.1 Power supply connection

The indicator is powered by adapter, you plug the adapter directly into the "DC" pin at the back cover the indicator is ok.

2.2 Connection of load cell and indicator

The indicator can connect with 6 load cell of 350Ω at most, 4 wire or 6 wire load cell both ok.

There are two methods connection between load cell and indicator

A. quick disconnect, as below:

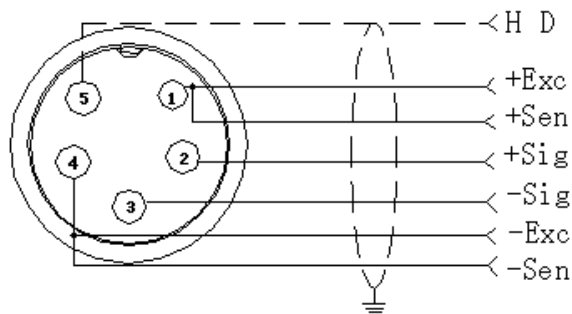

B. Terminal trip connection (inner connection)

1. the exciting voltage for the load cell is 5VDC, the largest output current 120mA, maximum connect 6 pcs 350Ω load cell;

2. Load cell (or the signal cable for the junction box) is connected with 5 bit

Terminal trip (J5) on the circuit-board of weighing indicator.

3. Open Weighing indicator back cover, insert signal cable to the terminal trip(J5), and make sure the screw is fixed tightly, the connection as below:

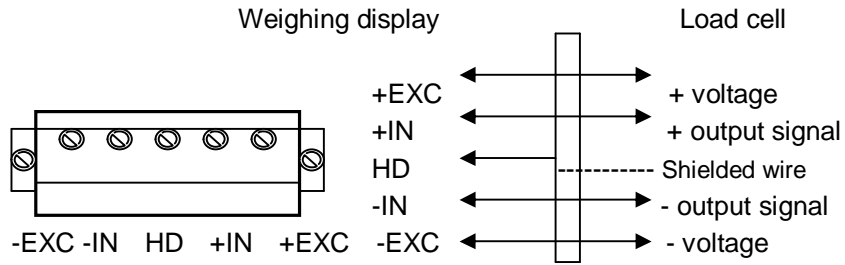

2.3 Communication interface

RS232 : DB9 Pin or 3 Pin

DB9 definition

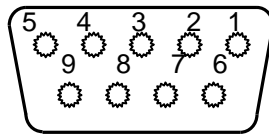

Pin function and definition as bellows:

DB9 joint	Definition	Function
2	TXD	Sending data
3	RXD	Receiving data
5	GND	Ground interface

Note: if RS485, The connection pin is 2 and 5 pin.

3 Pin definition

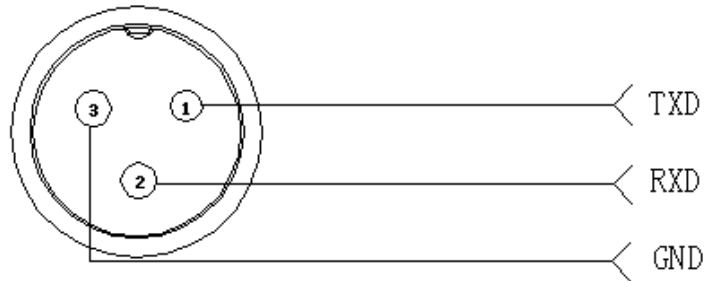

Inner connection

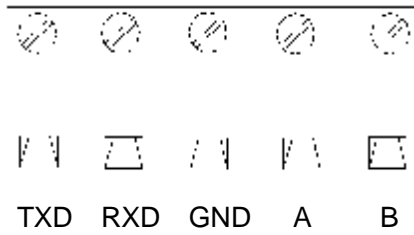

Pin definitions:

Pins	Definitions	Function
RS232	TXD	Sending data
	RXD	Receiving data
	GND	Ground
RS485	A	RS485 output "A" port
	B	RS485 output "B" port

2.4 4-20mA output

Technical parameters:

Resolutions: 1/1000

Outside Load: 100-350Ω

Connection:

1. Inside connection: 4-20mA, load input port connect with "1" of J2, Ground port connect with "GND" of J2
2. Outside connection: 4-20mA, load input port connect with "1" pin of D89, Ground port connect with "6" pin of DB9

Testing :

Connect the 250Ω to the 4-20mA, adjust the multimeter to the current stalls, the red pan connect the loading port, and the black pan connect " GND" to test the output current.

Calibration:

1. Press " Print" and " Total" go to C32, show[out-4], the output current should be 4mA.
2. If Press [↑]show[out-5], Pres[↓]show[out-20], the output current should be 20mA.
3. Adjust the current, for example, adjust to [out-20], the output current should be 12mA, if not 12mA. Press [←]("Zero" key)or[→](Net/gross key)to adjust the current to 12mA

2.5 Relay output signal function

The indicator can output 4 signal , connect with the outside equipment the indicator can perform automatic control function and upper limit and lower limit alarm function. Perform the 4 kinds function through setting C33, 4 signals

As below

	Output port	Port definition	Function
C33=0	Out1	Close output function	No output signal
	Out2	Close output function	No output signal
	Out3	Close output function	No output signal
	Out4	Close output function	No output signal
C33=1	Out1	Open overload control function	Output overload control signal
	Out2	Open compliance control function	Output compliance control signal
	Out3	Open underload control function	Output underload control signal

	Out4	Open stable control function	Output stable control signal
C33=2	Out1	Weight>=C13 instant connection	Feeding control signal
	Out2	Weight<=C14 instant connection	Feeding control signal
	Out3	OUT1、OUT2 close	When OUT1、OUT2 connect will output alarm signal, connect with buzzer
	Out4	Weight<=C14 constant connection Weight>=C13 disconnect	Feeding start and stop
C33=3	Preserved, no function.		

For example:

Check weigher application. Connect indicator with yellow, green, red 3 lights. Yellow light on when overload, if ok the green light on. If underload red light on. And can connect with buzzer. There would be alarm remind when overload.

C33=2 Feeding control application

For hopper scales. The target is between is 50~500kg, the Output card can perform open and close feeding valve.

Parameter setting C13=500kg C14=50kg

C13=500kg upper limit , close feeding valve

C14=50kg lower limit, open feeding valve.

Connection: 1. Connect directly control machine, pls. connect OUT 4, suggest connect another manually switch as the stop switch in emergency

2. indicator output signal will influence the ON/OFF switch to control machine, OUT 2 ON, OUT 1 OFF, OUT 3 connect buzzer, alarm remind when start and stop.

Instruction: when the weight over 500kg, OUT 1 OU3 instant connection and break off, OUT 4 break off; when weight under

50kg, OUT 2 OUT3 instant connection and break off, OUT 4 constant connection.

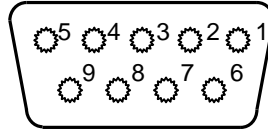

DB9 pin	definition	port
1 pin	1 st output signal pin	Out1
6 pin	1 st output signal pin	Out1
2 pin	2 nd output signal pin	Out2
7 pin	2 nd output signal pin	Out2
3 pin	3 rd output signal pin	Out3
8 pin	3 rd output signal pin	Out3
4 pin	4 th output signal pin	Out4
9 pin	4 th output signal pin	Out4

Inner connection pin definitions

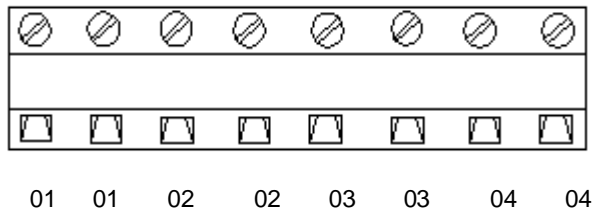



3. Basic operation

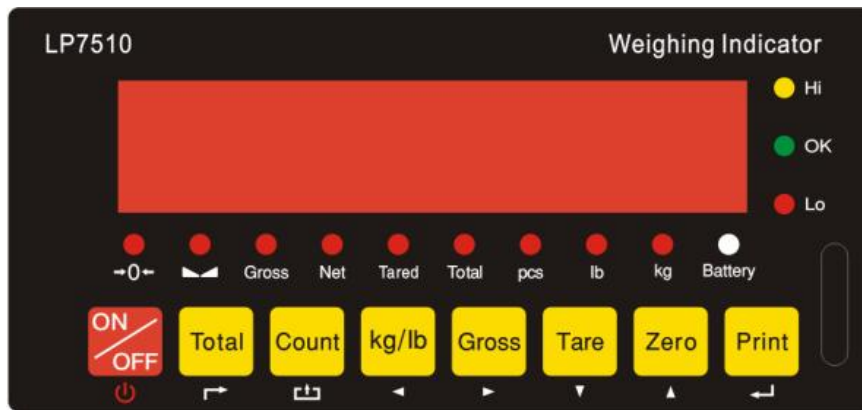
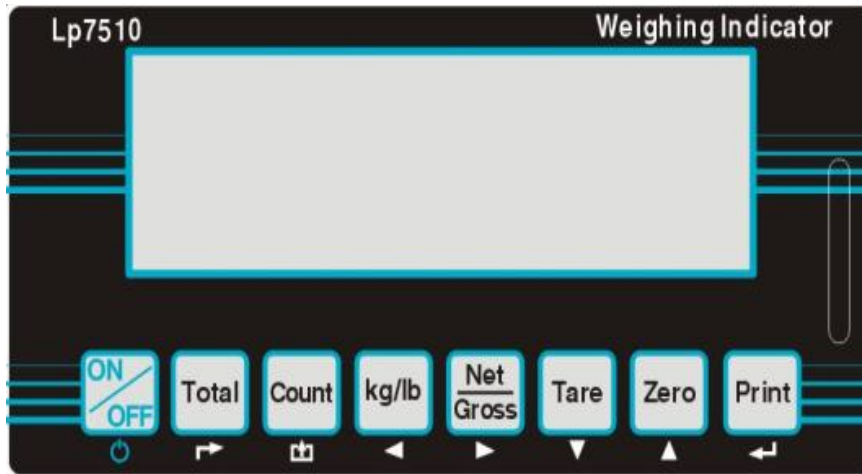



3.1 keypad







LED	instruction
	Weighing data
kg	kg
lb	lb

Hold	Data hold
Gross	Gross weight
Net	Net weight
Tare	tare
	The weighing data is stable
	Weight is zero
Hi	Overload
OK	ok
Lo	Underload
.	Decimal
PCS	Show the counting status.
TOTAL	Go to accumulation mode

Keys function

keys	Key name	Key function
	Print	1.work with "ZERO" TARE" "ON/OFF" key to perform many functions. 2.Print
	Zero	Zero the weight within tolerance
	Tare	At G.W mode, get the tare weight. At N.W mode, clear the tare, get the G.W
	Gross weight	At N.W mode, check the G.W, after 3 seconds back to N.W automatically

	Counting	Counting operation
	Kg/lb convert	Covert between kg and lb
	Accumulation	1. Accumulation 2. work together with “ Print” to perform The accumulation function and check the accumulation result
	Power on/off	Press 2 seconds to power on or power off

3.2

Power on & off



Press  2 seconds to power on or power off, after power on the indicator show “000000-999999”. After self inspection. It go to the weighing mode. Pls. check it whether 6 bits LED/LCD display and the status light is good or not.

3.3 Zero operation

1. Initial zero setting

When power on the indicator, if the weight on the scale is within the initial zero tolerance, indicator show zero automatically.

2. Manually Zero setting



When the scales is stable, and not the negative display, you can zero

the weight within tolerance by press  keys.

3.4 Tare operation

Press "TARE" key, the gross weight is tared, indicator show the Net weight, the "Net" "tared" status light is on. At tare mode, Press" TARE" key, clear the tare weight, the indicator will show the gross weight.

3.5 Accumulation operation

At Zero mode, load weight till stable, Press  go to accumulation mode, "Total" light on, display" n 001", and then display loaded weight; unload the weight , back to zero, load the second weight again till stable. Press  display"n002" then display the second loaded weight. Repeat it agin and again, maximum 999 times.

Check the accumulation

Press "ON/OFF "key and hold it then press "TOTAL"" key, display "n**", (it is the accumulating times) then show total weight. there are 8 digits totally. It shows the first 4 digits then the last 4 digits. For example, the first 4 digits is"0012", the last 4 digits is"34,56" It means the actual weight is "1234.56"

EXIT the accumulation function

When the indicator show the last 4 digits, Press  hold it, the indicator show " clr n", it means don't clear the total Weight, Press "PRINT" key to exit it; if you want to clear total weight, Press "ZERO" or "TARE" key, "clrn" change to "clry" it means clear total weight ,then Press "PRINT" to clear the total weight and exit accumulating mode.

3.6 Print

If the weighing is stable, after connect with printer, press" PRINT" can print the weight. Note: at tare mode, print with tare. if negative weight,, can not print. Set C30 for time format.

3.7 Hold

There are two different hold function. Peak hold function and data hold function. And the setting is different accordingly.

C11=3 Automatic hold function C11=0 close hold function.

3.8 COUNT

1. At weighing mode, load the weights on the platform scales, Press "Count" the indicator show "PCS 0" press "Zero" key input the quantity, press "Print" to confirm it

2. Load the goods on the platform scales, then the indicator will show the quantity.

3. Press "Count" back to weighing mode.

4. If you want to weigh different goods, at weighing mode, put the sample on the platform scales, press "Count" the indicator show "0" Press "Count" hold it and then press "ON/OFF" the indicator show "PCS 0", press "Zero" input the sample quantity, press "Print" to confirm it. Then repeat the step 2 and 3.

4. Calibration and Parameter setting

4.1 Enter setting

There have two methods to enter the setting menu:

1. when the switch "CAL" is off, press the "PRINT" hold it and then press "HOLD" enter C08-39 setting.

2. Take out the sealing screw on the back of indicator, then press "CAL", at the "SPAN" position as below. press "PRINT" hold it and then press "TOTAL" key, enter C01-C39 setting.

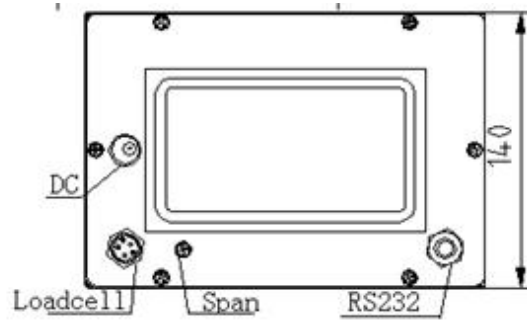

The key functions in setting:

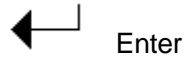

Enter



Up



Down



Left



Power switch. exit setting

4.2. Step of calibration operation:

According to the second method which can enter setting menu,
C01-C39

step	Method of operation	display	Remark
1		[C01]	After you enter calibration mode, it display [C01]
2	press ←	[C01 1]	Weight unit option: 1=kg 2=lb
3	press ← press ← press ↑ or ↓	[C02] [C02 0] [C02 2]	Set decimal digits option: 0/1/2/3/4 Select decimal digit

			example: two decimal point: [C02 2]
4	press ← press ← press ↑ or ↓	[C03] [C03 1] [C03 5]	Set graduation option: 1/2/5/10/20/50 Select required graduation example: graduation 5: [C03 5]
5	press ← press ← press ↑ or ↓ / ←	[C04] [0100.00] [0100.00]	Max capacity example: max weighing 100kg: [0100.00]
6	press ← press ← press ↑ press ←	[C05] [C05 0] [C05 1] [CAL 9] [0000.00]	Zero calibration Option 0=no need zero calibration 1=need zero calibration calibration zero please choose 1 and ensure scale is empty and “stable” light is on Ensure zero calibration, countdown. Till show[0.00](example for two decimal point)。
7	press ← press ← press ↑ or ↓ press ← press ↑ or ↓ press ←	[C06] [C06 0] [C06 1] [SPAN] [0100.00] [0080.00] [CAL 9] [0080.00] [CAL End]	calibration option: 0=No need calibration 1= need calibration Load weights on scales according to max. capacity. Suggest close to the max capacity, at least 10% of max. capacity. For example: the weights is 80kg As bellows: Input the 0080.00, count down ,

			then indicator shows 0080.00 , calibration is over. If you want to set application function parameter. Press "PRINT" if you want to exit press "TOTAL"
8	press ← press ← press ↑ or ↓	[C07] [07 0] [07 1]	Default parameters setting option:0=non-restore default parameters 1=restore default parameters Note: after the above parameters setting finish, please do not set default parameters to avoid the original setting parameters is lost.

4.3 Application function parameters setting chart

Function	Setting Item	parameters setting and instruction
warning tone	C08 warning tone	Options: 0 = close warning tone 1 = open warning tone
Automatic power off	C09 Automatic power off	option: 0=close auto power off 10= power off automatically if no change within 10 minute. 30= power off automatically if no change within 30 minute. 60= power off automatically if no change within 60 minute.
Power saving setting	C10 Power saving setting	LED Version: option: 0= close power saving setting 3= close display if no change within 3min. 5= close display if no change within 5 min. LCD Version:

		0=Close he backlight 1= backlight when the weight change or press the keyboard 2=constant backlight
Hold function	C11 Hold mode	option: 0=close hold function 1=Peak hold /2=Data Hold Instruction: Peak-hold: it shows the max. data, mainly application for materials testing, such as tension and pulling force. Date-hold: it shows current weight value. Mainly application for animal weighing.
Kg/lb conversion	C12 Kg/lb conversion	C12=0 stop kg/lb conversion C12=1 kg/lb conversion is ok
Upper/lower limit alarm	C13 Upper limit alarm value	You can set it within the max. capacity limit
	C14 Lower limit alarm value	
Inner Code display	C15 Check inner code	enter C15 to check the inner code

Date and time	C16 Date	Enter C16, you can set the date, from left to right: year/month/day
	C17 Time	Enter C17, you can set the time from left to right: hour/min./sec.
Communication setting	C18 Serial interface data output method	option: 0= Close serial interface data output 1=Continuous sending, connect second display

		<p>2=Print method, connect printer.</p> <p>3=Command request method , connect computer.</p> <p>4=PC continues sending format, connect computer.</p> <p>5=PC/ second display continuous sending format.</p>
	<p>C19 Baud rate</p>	<p>option: 0=1200/1=2400/2=4800/3=9600</p>
Zero range	<p>C20 Manually zero range</p>	<p>Option: 0= close manually zero setting 1=$\pm 1\%$ max capacity 2=$\pm 2\%$ max capacity 4=$\pm 4\%$ max capacity 10=$\pm 10\%$ max capacity 20=$\pm 20\%$ max capacity 100=$\pm 100\%$ max capacity</p>
	<p>C21 Initial zero range</p>	<p>option: 0= no initial zero setting 1=$\pm 1\%$ max capacity 2=$\pm 1\%$ max capacity 5=$\pm 1\%$ max capacity 10=$\pm 1\%$ max capacity 20=$\pm 1\%$ max capacity</p>
Zero tracking	<p>C22 Automatically zero tracking range</p>	<p>Options: 0= close zero tracking 0.5=$\pm 0.5d$ 1.0=$\pm 1.0d$ 2.0=$\pm 2.0d$ 3.0=$\pm 3.0d$ 4.0=$\pm 4.0d$ 5.0=$\pm 5.0d$</p> <p>Note: 1. d = division 2. the zero tracking range can</p>

		not bigger than manual zero range.
	C23 Automatically zero tracking time	Options: 0= close zero tracking time 1= 1 second 2= 2 seconds 3= 3 seconds
Overload range	C24 Overload range	option: 00= close overload range 01d~99d remark: d =division
Negative display	C25 Negative display range	Option: 0=-9d 10=10% max. capacity 20=20% max. capacity 50=50% max. capacity 100=100% max. capacity
Standstill time	C26 Standstill time	Option: 0= quick 1= medium 2= slow
	C27 Standstill range	Option: 1= 1d 2=2d 5=5d 10=10d D= division

Digital filter	C28 Dynamic filter Instruction : Dynamic filter is collecting the data filter before loaded weight stable. When loaded weight easily shaking (for example animal) , you can set this filter to make weight display more stable	option: 0= close dynamic filter 1=1 digital filter strength 2=2 digital filter strength 3=3 digital filter strength 4=4 digital filter strength 5=5 digital filter strength 6=6 digital filter strength Note : Pls setting dynamic filter strength carefully, the No. is bigger, more stable. if the loaded weight shake not too much. The setting is less than 3
	C29 Noise filter	option: 0=close noise filter 1=1 digital filter strength 2=2 digital filter strength 3=3 digital filter strength
	C30 Print time and date	C30=0 yy.mm.dd C30=1 mm.dd.yy C30=2 dd.mm.yy C30=3 yy.mm.dd
Analog output setting	C31 output type	C31=0 0~5Voutput C31=1 4~20mA output
4~20mA current calibrate	C32 calibrate current	Refer to 2.5
Relay output setting	C33 Relay output	C33=0 close relay output C33=1 Open relay output function 1 C33=2 Open relay output function2 C33=3 Preserved menu

Muti communication add.	C34 Communication add.	C34= 0~99 Add. Code
Wireless communication	C35	C35=0~99 signal
Gravity of calibration location	C36	C36=9.7000~9.9999
Gravity of destination Version No.	C37 C38	C37=9.7000~9.9999
Preserved menu	C39	

5. Output format

5.1 Second display continuous sending format

Output continuous format																	
S	S	S	S	X	X	X	X	X	X	X	X	X	X	X	X	C	C
T	W	W	W												R	K	
X	A	B	C												S	S	
1	2		3				4				5	6					

State A			
Bits0,1,2			
0	1	2	Decimal point position
1	0	0	XXXXXX0
0	1	0	XXXXXXX
1	1	0	XXXXX. X
0	0	1	XXXX. XX
1	0	1	XXX. XXX
Bits3,4			Division
0		1	X1
1		0	X2

State B	
BitsS	function
Bits0	gross=0, net=1
Bits1	Symbol: positive =0,negative =1
Bits2	Overload(or under zero)=1
Bits3	dynamic=1
Bits4	unit: lb=0, kg=1
Bits5	Constant 1
Bits6	Constant 0

State C			
Bit2	Bit1	Bit0	unit
0	0	0	Kg or lb
0	0	1	g
0	1	0	t
Bit 3			printing=1
Bit 4			Extend display=1
Bit 5			Constant 1
Bit 6			Constant 0

5.2 Computer continuous sending format

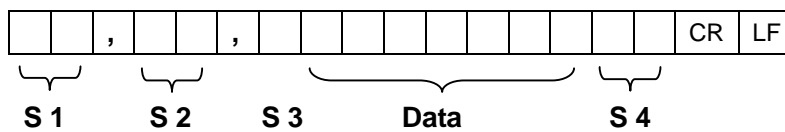

- S1: weight status, ST= standstill, US= not standstill, OL= overload
- S2: weight mode, GS=gross mode, NT=net mode
- S3: weight of positive and negative, "+" or "-"
- S4: "kg" or "lb"
- Data: weight value, including decimal point
- CR: carriage return
- LF: line feed

5.3 Serial interface reception command:

RS232COM serial interface can receive simple ASCII command.
Command word and role as follows:

Command	NAME	Function
T	TARE	Save and clear tare
Z	ZERO	Zero gross weight

P	PRINT	Print the weight
R	G.W/N.W	Read gross weight or net weight
C	Kg/lb	Kg/lb conversion
G	G.W	Check gross weight at net weight mode

R command receive data format

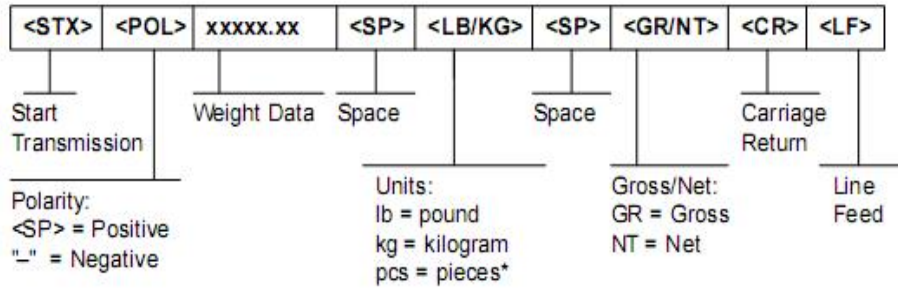

5.4 Print format

ID.NO. 004 (Serial No.)
Date: XX.XX.XX (yy.mm.dd)
Time: XX.XX.XX (hh.mm.ss)
GROSS 8.88kg (gross weight)
TARE 2.88kg (tare)
NET 6.00kg (net weight)

5.5 PC or Second display continuous sending format

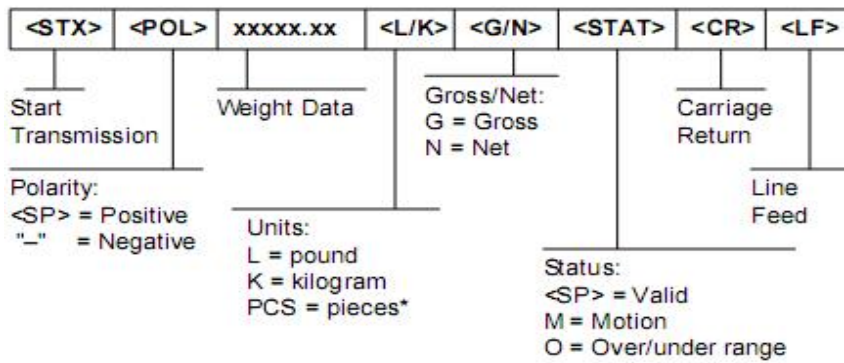

6. Maintenance

6.1 Regular error and solution

ERROR	REASON	SOLUTION
UUUUUU	<ol style="list-style-type: none"> 1. Overload 2. wrong connection with load cell 3. load cell has quality problem. 	<ol style="list-style-type: none"> 1. reduce the weight 2. check load cell connection 3. inspection load cell. Check the input and output
nnnnnnn	<ol style="list-style-type: none"> 1. calibration is no good 2. wrong connection 3. load cell has quality problem 	<ol style="list-style-type: none"> 1. check scale is resisted or not, foot is kept level or not. 2. check load cell connection. 3. checking load cell: check input and output resistance to judge it is good or not.
ERR1	During calibration, not input the weights or the weight is overload	Input the correct weights
ERR2	During calibration , the weights is below than Min. required weights	The calibration weights Minimum is 10% of Max. cap. Recommend 60%-80% of Max. Cap.
ERR3	During calibration, the input signal is negative	<ol style="list-style-type: none"> 1. check the connection is correct 2. check load cell is no problem 3. recalibration if still wrong change the PCB

ERR4	During calibration, the signal is unstable	After the platform is stable, start calibration
ERR5		Change PCB

6.2 Daily maintain

1. Protect the indicator from strong sunlight to prolong the using life
2. Good connection between load cell and indicator. Far from away from strong electric field, magnetic field.
3. Power off the indicator when lightning
4. Power off the indicator firstly before plug and unplug

6.3 Restore default parameter

Enter to calibration, Set C07=1. Press" PRINT" then press" TOTAL" to exit saving setting. All parameter will back to default

Note : Pls. do not restore default parameter easily if you are not professional staff or not yet calibrate the scales.

Default parameter

Parameter	instruction	Default
C01	Calibration	1
C02	Decimal digits	0
C03	Resolution	1
C04	Max. capacity	10000
C05	Empty calibration	0
C06	Capacity calibration	0
C07	Restore default	0
C08	Warning tone	1
C09	Power-off automatically	0
C10	Power saving mode	0

C11	Hold function	0
C12	Prohibit kg/lb conversion	1
C13	Upper limit alarm	000000
C14	Under limit alarm	000000
C15	Inner code	
C16	Date setting	
C17	Time setting	
C18	Serial interface data output	0
C19	Serial interface Baud rate	3 (9600)
C20	Zero manually	10
C21	Initial zero	10
C22	Zero tracking range	0. 5
C23	Zero tracking time	1
C24	Overload range	9
C25	Negative range	10
C26	Standstill time	1
C27	Standstill range	2
C28	Dynamic filter	0
C29	Noisy filter	2
C30	Print format	0
C31	Analog signal options	1
C32	4~20mA testing	4
C33	Relay output setting	1
C34	Muti PC communication add.	0
C35	Wireless communication channel	6
C36	Calibration location gravity	9.7936
C37	Destination gravity	9.7936
C38	Version No. check	
C39	Reserved menu	

6.4 Packing list

Packing list

S/N	ITEM	NAME	UNIT	QTY	PACKING
1	Weighing indicator		PCS	1	
2	Plastic bag		PCS	1	
3	bag		PCS	1	
4	Adapter	China/DC9V	PCS	1	
		US/DC9V	PCS	1	
		UK/DC/9V	PCS	1	
		EU/DC9V	PCS	1	
		AU/DC9V	PCS	1	
		OTHERS	PCS	1	
5	USER MANUAL		PCS	1	
6	RS232	3 PIN OR DB9	PCS	1	
7	LOADCELL PLUG	5 PIN Quick disconnect	PCS	1	
8	Signal cable	Φ5/3 core shield signal cable	PCS	1	
9	Power cable	3 coreΦ0.75mm	PCS	1	
10	Bracket	Wall-mounted	PCS	1	
11	Certificate		PCS	1	
12	Packing list		PCS	1	